

# EUROSTER 813

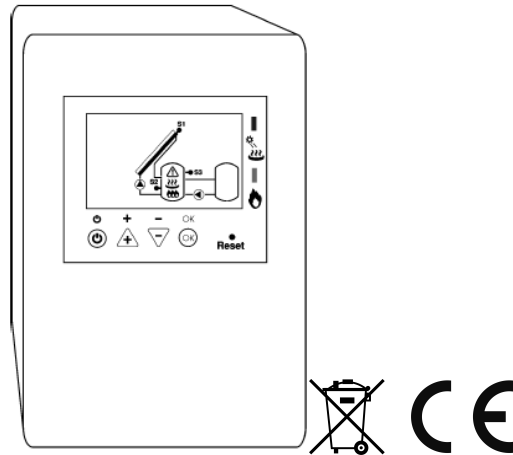

## INTRODUCTION

The **Euroster 813** is a din-rail mount Solar controller for a domestic water heating system. It is designed to be used as differential temperature controller to control a solar collector and maximum 2 storage tanks subject to the chosen operating mode.

The controller is able to control an auxiliary heating (boiler or electric) elements to provide supplementary heat. Users can program the required time schedule to automatically start-stop the auxiliary heating.

The unit provides 4 operating modes for users to choose from. A preventive measure is build-in to prevent error from occurrence whilst in selecting the required operating mode. Graphic of each required mode that will be shown on the LCD of the unit, as below.

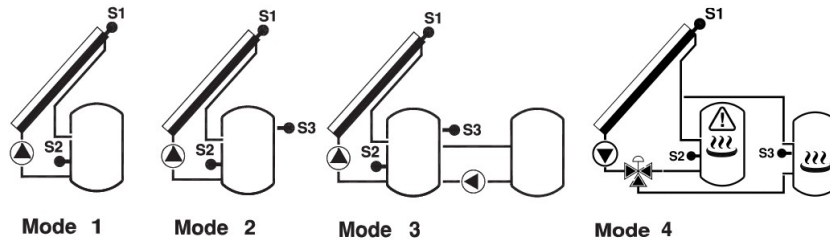

## Graphic descriptions to operation logic in each of 4 operating modes:

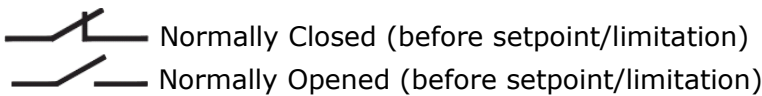

**Mode-1:** 2 sensor operation with 1 storage tank

- S1** - Solar collector temperature sensor
- S2** - Lower storage tank temperature sensor

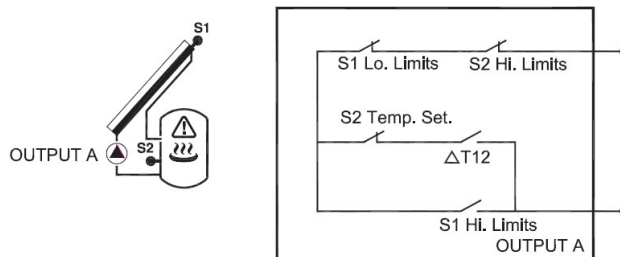

**Mode-2:** 3 sensor operation with auxiliary heater

- S1** - Solar collector temperature sensor
- S2** - Lower storage tank temperature sensor
- S3** - Thermostatic sensor

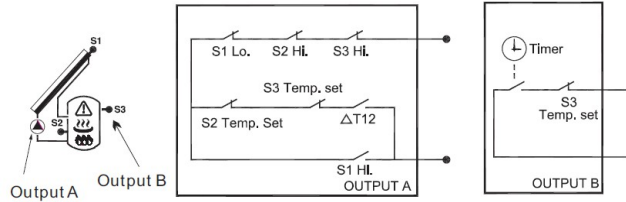

**Mode-3:** 3 sensor operation with auxiliary boiler

- S1** - Solar collector temperature sensor
- S2** - Lower storage tank temperature sensor
- S3** - Thermostatic sensor

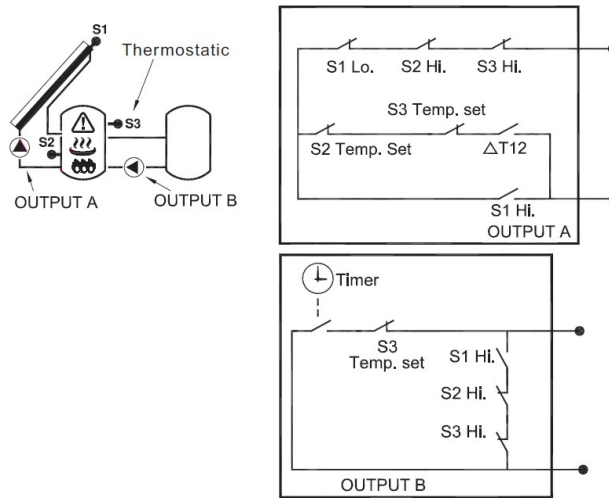

**Mode-4:** 3 sensor operation with 2 storage tanks

- S1** - Solar collector temperature sensor
- S2** - Lower storage tank temperature sensor
- S3** - Differential temperature sensor

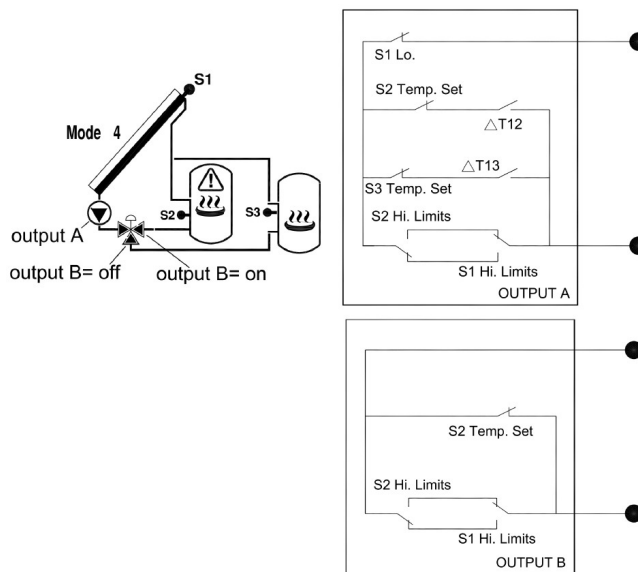

The control-logic of Euroster 813 explained in the graphic descriptions

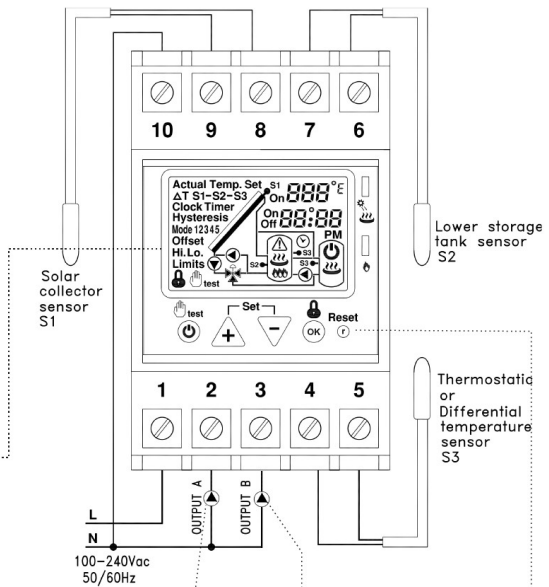
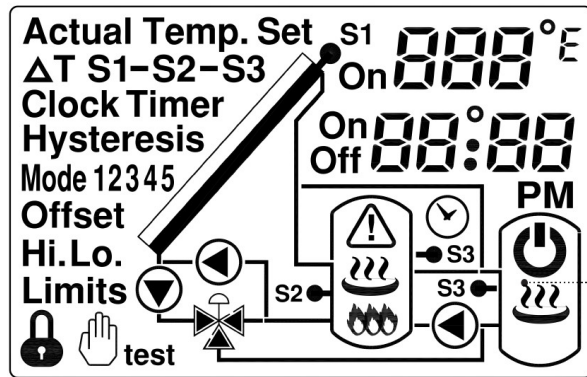

Turned on : Differential Temp.(S1-S2)>ΔT setpoint  
 Turned off : Differential Temp.(S1-S2)<ΔT setpoint:  
 The same in all 4 modes

In Mode-2 and Mode-3  
 Turned on : Temp. < setpoint in S3  
 Turned off : Temp. > Setpoint in S3

in Mode-4  
 Turned on : Differential Temp.(S2-S3)>ΔT setpoint  
 Turned off : Differential Temp.(S2-S3)<ΔT setpoint

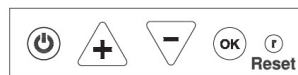
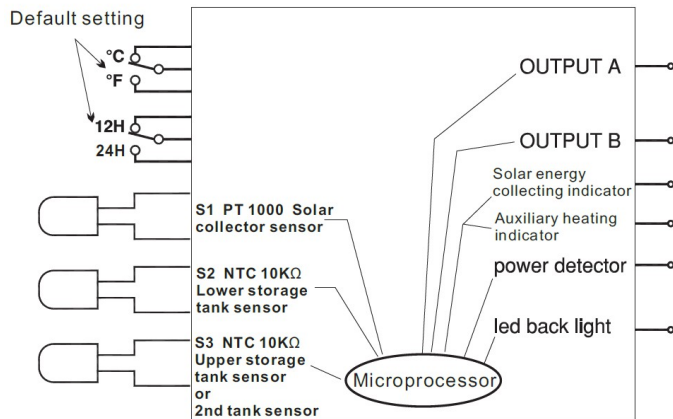

1. Operating voltage : 100 ~ 240 V AC 50/60 Hz
2. Output rating : (Solar collector circulation Pump) Output A - Volt output, 7 Amp \ 250 V AC (Auxiliary heating) Output B-Volt output, 16 Amp\250 V AC
3. Power consumption:4 VA
4. Clock format : 12H/24H by preset. Default setting 24H
5. °C/°F : By preset. Default setting °C (build-in Protective functions)
6. Anti-seizing protection : Automatic operation, the **Output A** will be turned on for 5 seconds everyday at midnight 12:00 (00:00) when the night temperature is below 15°C.
7. **Overheating protection: Automatic operation, when this protection is activated, backlight and will be synchronous flashing on the LCD.**

**Overheating in the solar collector*****In operating mode-1/2/3***

**Output A** will be turned on when **S1** temperature  $\geq$  **S1** Hi temp. limits. setpoint and **S2** temperature  $\leq$  **S2** (Hi temp. limits. Setpoint -2°C)

**Output A** will be turned off when **S1** temperature  $\leq$  (**S1** Hi temp. limits. setpoint -5°C) and **S2**  $\leq$  **S2** Hi temp. limits. setpoint

***In operating mode-4***

**Output A&B** will be turned on when **S1** temperature  $\geq$  **S1** Hi temp. limits setpoint and **S2** temperature  $\leq$  (**S2** Hi temp. Limits Setpoint -2°C)

**Output A&B** will be turned off when **S1** temperature  $\leq$  (**S1** Hi temp. limits. setpoint -5°C) and **S2** temperature  $\leq$  (**S2** Hi temp. Limits. setpoint-2°C)

**Overheating in the storage tank*****In operating mode-1/2/3***

**Output A** will be turned on when **S2** temperature  $\geq$  **S2** Hi temp. limits setpoint and **S1** temperature  $\leq$  (**S1** Hi temp. limits. setpoint -5°C)

**Output A** will be turned off when **S2** temperature  $\leq$  (**S2** Hi temp. limits. setpoint -2°C) and **S1** temperature  $\leq$  **S1** Hi temp. limits. setpoint

***In operating mode-4***

**Output A&B** will be turned on when **S2** temperature  $\geq$  **S2** Hi temp. limits. setpoint and **S1** temperature  $\leq$  (**S1** Hi temp. limits. setpoint -5°C)

**Output A&B** will be turned off when **S2** temperature  $\leq$  (**S2** Hi temp. limits. setpoint -2°C) and **S1** temperature  $\leq$  **S1** Hi temp. limits. setpoint

8. Anti-frost protection : Active when the unit is ON (in operation)

**Output A** will be turned on for 1 minute in every hour when **S1** temperature = 5°C.

**Output A** will be permanent turned on when **S1** temperature = 2°C, until **S1** > 5°C.  
Enable(ON) or disable(OFF) this function is selectable. Default setting : OFF

**(Set/adjust all the setpoints in the S1,S2 and S3)**

9. Set/adjust the "Hi. Temp. Limits." (the overheating protection temperature setpoint)

**S1** : Setting range from 60°C to 190°C. Default setting 120°C

**S2** : Setting range from 0°C to 100°C. Default setting 95°C

10. Set/adjust the "Lo Temp. Limits" (the lowest temperature protection setpoint):

Only in the **S1**

Output A will be shut off when temperature at **S1** is lower than "Lo Temp. Limits" Setting range from 10°C to 40°C. Default setting 15°C

11.  $\Delta T$  **S1-S2** (Turn ON or OFF the solar collector circulation pump to the differential setpoints)

**ON** :The minimum required temperature difference between **S1** temperature at Solar panel and **S2** temperature at the lower of storage tank which is for turning ON **Output A**.

Setting range:3~20°C, default setting 10°C

**OFF**:The minimum required temperature difference between **S1** temperature at Solar panel and **S2** temperature at the lower of storage tank which is for turning OFF Output A to avoid reverse circulation.

Setting range:1~18°C, default setting 3 °C

12.  $\Delta T$  **S2-S3** (Turn ON or OFF the Circulation pump to the differential setpoints) Effects in operating mode-4 only

**ON**:The minimum required temperature difference between **S2** temperature at the lower of 1st storage tank and **S3** temperature at the lower of 2nd storage tank which is for turning ON **Output B**. Setting range: 3~20°C, default setting 10°C

**OFF**:The minimum required temperature difference between **S2** temperature at the lower of 1st storage tank and **S3** temperature at the lower of 2nd storage tank which is turning OFF **Output B**. Setting range:1~18°C, default setting 3°C

13. Set/adjust the temperature setpoints at **S2&S3** and their Switching differential (Hysteresis)

These setpoints will provide this unit with the thermostatic operation to automatically

maintain the water in the storage tanks at the required temperature.

The setpoint at **S2** controls the ON/OFF in Output A.

The setpoint at **S3** controls the ON/OFF in Output B.

**S2** : Setting range from 10°C to 100°C. Default setting 60°C

**S2** : Switching differential : Setting range from 1°C to 20°C. Default setting 2°C

**S3** : Setting range from 10°C to 100°C. Default setting 60°C

**S3** : Switching differential : Setting range from 1°C to 20°C.  
Default setting 10°C, in mode-2 and mode-3  
Default setting 2°C, in mode-4

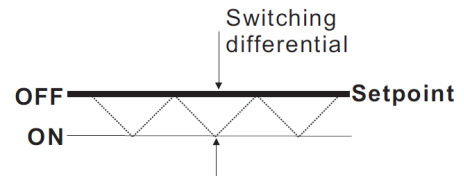

#### 14. TIMER function

Active only in the operating mode -2 or 3, ON/OFF controls to the time setpoints in the **Output B (S3)**. For solar collector systems with auxiliary heating. Enable or disable this function is selectable. When the TIMER function is enabled, 2 ON-OFF(program-periods) /Day provided, program-resolution : 10 minutes. Default setting : OFF

#### 15. Temperature sensor cable

**Collector sensor S1** --- PT1000, 1K $\Omega$  at 0°C, Temp. Coefficient 3.9x10 / °C. Resistance variable rate 0.3851 $\Omega$ /°C. Temperature display range -40~ + 250°C/-40~482°F, Accuracy  $\pm 0.5$  °C/1.0 °F. Cable length:2meters,thermal-resistive PTFE shielding

**Tank sensor S2** --- NTC, 10K $\Omega$  at 25°C.

Temperature display range -10 ~ +110 °C/-14 ~ 230°F

Accuracy  $\pm 0.5$  °C /1.0 °F. Cable length : 1,5 meters , thermal-resistive PTFE shielding.

**Tank sensor (thermostatic) S3**---NTC, 10K $\Omega$  at 25°C.

Temperature display range -10 ~ +110 °C /-14 ~ 230°F. Accuracy  $\pm 0.5$  °C /1.0 °F. Cable length : 1,5 meters, thermal-resistive PTFE shielding.

#### 16. Temperature sensor's calibration : Offset (The same Offset range in all 3 sensors)

Range : -10°C ~ + 10°C,default setting 0°C

#### 17. Build-in Rechargeable battery for retaining the settings and the time during power outages

#### 18. Stand-By mode

Manually turn the unit ON/OFF (**Output A&B** can be turned-on/shut-off manually)

#### 19. Key-lock function

Lock out of all the buttons on the front control-panel, prevents the settings from being tampered with.

#### 20. Anti-Legionella function

Effective only in **S3**. used for control the auxiliary heating.(Control of **Output B**).

This function will operate manually only, when it is in operation, **Output B** will be turned on to heat up the water. When the water temperature reaches the setpoint, **Output B** will continue to operate for a duration of (1080- (12x Anti-legionella temperature setpoint)) Seconds. After, the unit will resume its normal operation.

Anti-legionella temperature setpoint: Setting range from 60°C to 90°C. Default setting 70°C

#### 21. Blue backlit LCD, auto mode 10 seconds

#### 22. Dimensions:52.5Wx85.0Hx60.0Dmm. 35 mm Din-rail

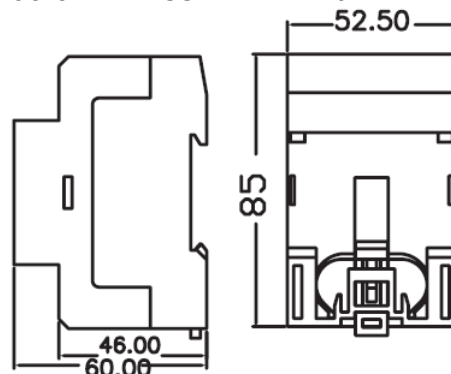

**Remove battery insulation before wiring**

**Wiring**

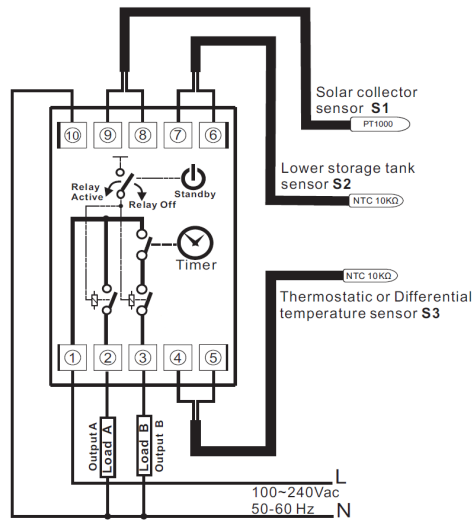

The retractor on the back of the plastic housing is for clamping the unit on the Wall or Rail. Follow the graphic description below when mounting the unit.

<p style="text-align: center;">①</p>	<p style="text-align: center;">②</p>
<p>Insert a Flat-head screw-driver in the position as shown above.</p>	<p>Tilt the screw-driver to the direction as shown above to push down the retractor.</p>

**Mount/Remove the unit in surface-mount**

	<p style="text-align: center;">Mount</p>	<p style="text-align: center;">Remove</p>
<p>Mount the provided surface-mount bracket on the wall.</p>	<p>Align the top of back plastic housing with the top of the bracket. Push down the retractor and mount.</p>	<p>Push down the retractor to remove the unit off the bracket.</p>

**Mount/Remove the unit in din-rail mount**

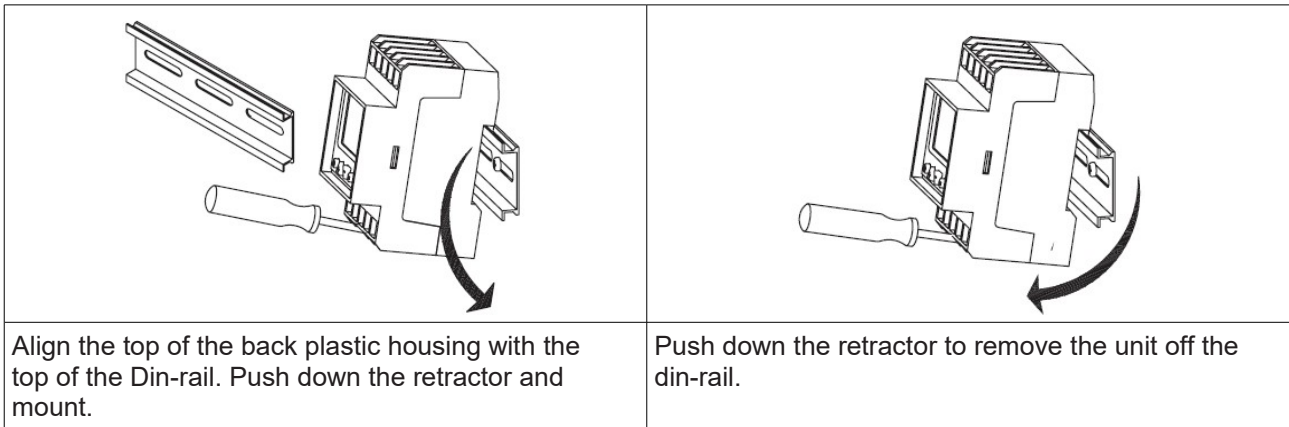

Align the top of the back plastic housing with the top of the Din-rail. Push down the retractor and mount.

Push down the retractor to remove the unit off the din-rail.

**Product description**

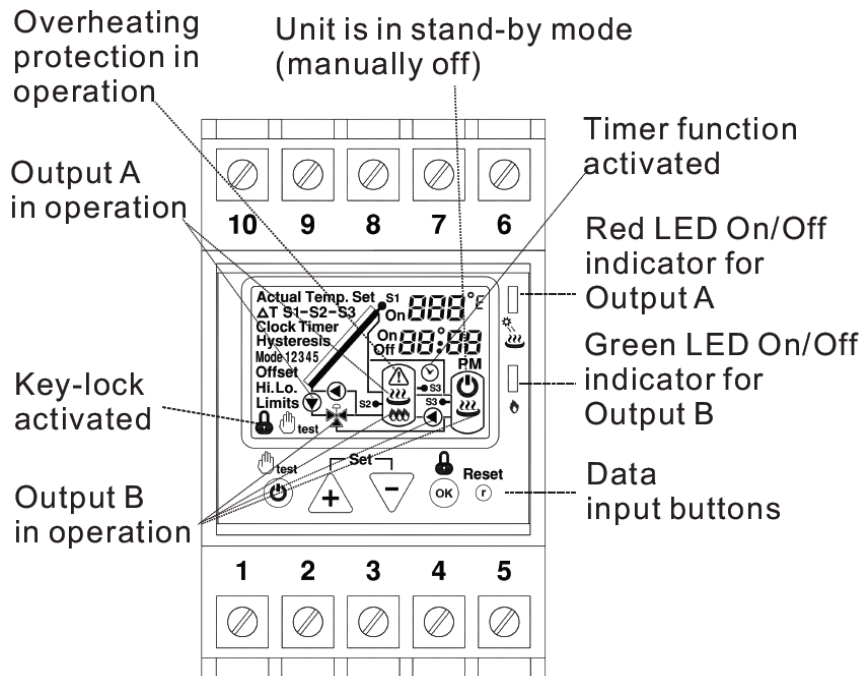

**Set\Adjust internal settings**

We suggest that you read the specification thoroughly before starting to set/adjust the unit.

This unit has preventive measures to avoid errors whilst in selecting the required operating mode.

When the error occurs, "Err" will be shown on LCD.

If this situation occurs, either press "reset" or press and together for 5 seconds to restart setting/adjusting.





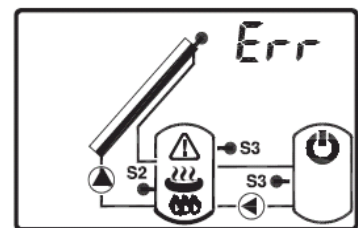

Press "reset" prior to starting to set/adjust for first time use.

In the setting/adjusting procedure, if no data is input after 1 minute, this unit will automatic retain the settings and start to operate. Users may use this when just making adjustments in the internal settings.



Press and together for 5 seconds to start setting/adjusting



**A. Set/Adjust the Clock**



1. Press  or  to set the correct Hour of the day
2. Press  to set the Minutes.
3. Press  or  to set the correct minutes
4. Press  to set/adjust next setting.

**B. Anti-frost protection A-F (refer to the page of Specification Item-8 for a detailed description)**



1. Press  or  to choose Enable (ON) or Disable(OFF) this function.

**C. Set/Adjust the required operating mode**



This unit provides 4 operating modes, we suggest that you read the "Introduction" thoroughly in this Instructions before choosing.

1. Press  or  to choose the required mode
2. Press  to go to the next setting.



**C1 - Hi Limits S1 (Refer to the page of Specification Item-7 & 9 for a detailed description)**

1. Press  or  to choose the required setpoint
2. Press  to go to the next setting.







**C-2 Lo Limits S1 (Refer to the page of Specification Item-10 for a detailed description)**

1. Press  or  to choose the required setpoint
2. Press  to go to the next setting.







**C-3 Hi Limits S2 (Refer to the page of Specification Item-7 & 9 for a detailed description)**

1. Press  or  to choose the required setpoint.
2. Press  to go to the next setting.





**D. ΔT S1-S2 ON and OFF setpoints (Refer to the page of Specification Item-11 for a detailed description)**

1. Press  or  to choose the required ON setpoint
2. Press  to go to the next setting.
3. Press  or  to choose the required OFF setpoint.
4. Press  to go to the next setting.

**E. ΔT S2-S3 ON and OFF setpoints (Refer to the page of Specification Item-12 for a detailed description)**

1. Press  or  to choose the required ON setpoint.
2. Press  to go to the next setting.
3. Press  or  to choose the required OFF setpoint.
4. Press  to go to the next setting.  
(Effects in operating mode-4 only)







**F. Set/Adjust Operation setpoint and Hysteresis (Switching differential) in S2 (Thermostatic in Output A. Refer to the page of Specification Item-13 for a detailed description)**

1. Press  or  to choose the required setpoint.
2. Press  to go to the Hysteresis setpoint
3. Press  or  to choose the required Hysteresis setpoint.











4. Press  to go to the next setting

**G. Set/Adjust Operation setpoint and Hysteresis (Switching differential) in S3 (Thermostatic in Output B. Refer to the page of Specification Item-13 for a detailed description)**













1. Press  or  to choose the required **S3** point
2. Press  to go to the Hysteresis setpoint.
3. Press  or  to choose the required hysteresis setpoint
4. Press  to go to the next setting.  
(Effects in operating mode-2/ 3/ 4 only)

**H. Offset – Temperature sensor's calibration ( Refer to the page of specification Item-15/16 for a detailed description)**



1. Press  or  to choose the required temperature calibration value in **S1**.
2. Press  for the calibration in **S2**.
3. Press  or  to choose the required value.
4. Press  for the calibration in **S3**
5. Press  or  to choose the required value.
6. Press  to set the next setting  
(Calibration in **S3** effects in operating mode-2 / 3 / 4 only)

**I. Timer function (Refer to the page of introduction and the page of Specification Item-14 for a detailed description, 2 program-periods are provided in this unit)**



For setting the Timer, press and hold  for fast forward press and hold  for fast backward

1. Press  to enable the Timer function and to choose the required ON/OFF time in each program.
2. Press  or  to choose the time for **P-1 ON**
3. Press  to set the **P-1 OFF** time
4. Press  or  to choose.
5. Press  to set the **P-2 ON** time
6. Press  or  to choose.
7. Press  to set the **P-2 OFF** time.
8. Press  or  to choose.  
(Timer function activates in Mode-2 or 3 only)
9. Press  to go to the next setting

All internal settings are now completed, press  to start operation.

When this unit is in operation, press  or  to check the temperature of each temperature sensor.

**Stand-by mode**

1. Press .
2. A Flashing „YES” will show on the LCD.
3. Press  again.
4. This unit is now manually turned off.

**Remark:**

When this unit was manually turned off, the build-in protective function will be automatically

activated.

⚠ Refer to the page of Specification Item-6 Anti-seizing protection for the details.

When this unit is operating in stand-by mode, pressing the  button will resume its operation.

**Remark:**

Under two situations the backlight on the LCD will be flashing to alert users;

1. When this unit is in operating the overheating protection, it will display on the LCD;

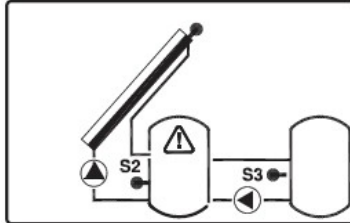

2. If any of the temperature sensor is not properly connected or has been damaged, it will display on the LCD;

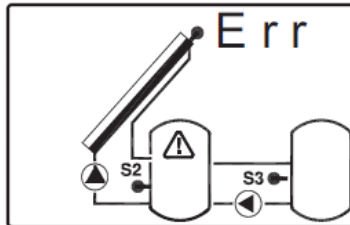





Also the symbol of on the LCD will be synchronously in flashing. Immediate contact service persons if this situation has occurred.

**Anti-legionella function**

This function activates only in systems equipped with auxiliary heating devices (mode-2 or 3).

Refer to the page of Specification Item-20 for a detailed description

1. Press and hold  for 5 seconds.
2. Press  or  to set the required temperature setpoint for this Hygienic function.
3. Press  to start to operate this function

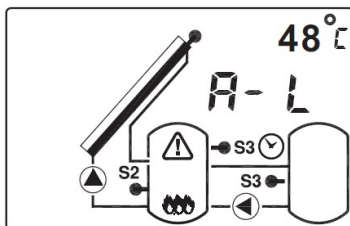

When this unit is operating the anti-legionella function, the LCD will show A-L and the **S3** temperature.

Press  again will stop the operation.

This unit will automatic resume its normal operation after the anti-legionella function.

If the temperature at **S3** could not reach the required A-L setpoint after this function has been in operation for one hour, the backlight will be flashing to alert users that the anti-legionella function has failed to operate.



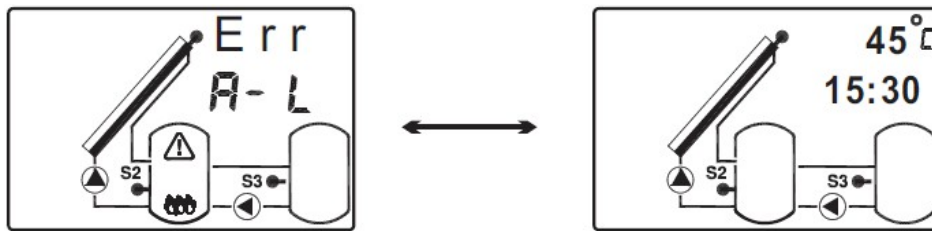



The display on the LCD will alternately show



Press **OK** to stop this A-L operation and immediately contact service personnel when this situation has occurred.

### Test mode test

Check if both **Output A and B** are in good condition and ready to start operation. ( In mode-1, Output A only)

1. Press and hold **OK**, then press **+**.
2. Slow flashing **Output A** () will be shown on the LCD.
3. Press **+** to turn on **Output A**.
4. If **Output A** is in good condition, a fast flashing () will be shown on the LCD and the red LED  on the top right corner of panel will be turned on. (Unit may be damaged if above situation did not occur)
5. Press **-** to turn off the test on **Output A**.
6. Press **OK** to test **Output B**.
7. Slow flashing **Output B** () or **S3** in mode-2 ) will be shown on the LCD.
8. Press **+** to turn on **Output B**.
9. If **Output B** is in good condition, a fast flashing () will be shown on the LCD and the green LED  on the top right corner of panel will be turned on. (Unit may be damaged if above situation did not occur)
10. Press **-** to turn off the test on **Output B**.
11. After test, press and hold **OK** and then press **+** to start operation.

### Resume default settings

Press **Power** and **OK** together. „dEL” will be shown on the top right of the LCD. All default settings will be resumed, the time will however be retained.

### Reset

Press “Reset” , the previous settings will be retained, however the time setting will be erased.

### Key-lock function

(Refer to the page of Specification Item-19 for a detailed description)

Press **-** and **OK** together.  will be shown on the bottom left of the LCD. Any data input through the buttons on the panel is now invalid.

When the unit is in Key-lock mode, press **-** and **OK** together to release the Key-lock.

**SIMPLIFIED DECLARATION OF EU CONFORMITY**

P.H.P.U. AS AGNIESZKA SZYMAŃSKA-KACZYŃSKA hereby declares that the type of Euroster 813 equipment conforms to the following directives: 2014/35/EU (LVD), 2014/30/EU (EMC), 2011/65/EU (RoHS).

**The complete text of the Declaration of EU conformity is available at the following Internet address: [www.euroster.pl](http://www.euroster.pl)**

**ELECTRONIC WASTE MANAGEMENT INFORMATION**

This product is designed and manufactured of high quality materials and components suitable for reuse.

The crossed out wheellie bin symbol located at the product means that the product is subject to selective collection in accordance with the provisions of the Directive 2012/19/EU of the European Parliament and of the Council.

The product contains an internal battery subject to the selective collection in accordance with the provisions of the Directive 2006/66/EC of the European Parliament and of the Council.

Such marking informs that the electrical and electronic equipment and batteries may not be disposed of together with other household waste after their service life. The user is obliged to take the used devices and batteries to a point of collection of waste electrical and electronic equipment and batteries. The entities collecting such equipment, including the collection points, shops, and municipal entities, set up an appropriate system enabling handover of such equipment and batteries.

The proper disposal of waste equipment and batteries contributes to prevention of consequences hazardous to the health of persons and nature, resulting from the possible presence of hazardous components in the equipments and batteries and from inaccurate storage and processing of such equipment and batteries. The guidelines regarding disposal of the batteries are included in the user manual.

A household plays an important role in contributing to reuse and recovery including recycling, of the waste equipment. The attitudes influencing protection of the common good of clean environment are shaped at this level. Households are also one of the larger users of small equipment and its rational management at this stage impacts the recovery of recyclables. Inaccurate disposal of this product may be penalised in accordance with national legislation.

**GUARANTEE CERTIFICATE****EUROSTER 813**

Warranty terms:

1. Warranty is valid for 24 months from the controller sale date.
2. Claimed controller together with this warranty certificate must be supplied to the seller.
3. Warranty claims shall be processed within 14 business days from the date the manufacturer has received the claimed device.
4. Controller may be repaired exclusively by the manufacturer or by other party clearly authorized by the manufacturer.
5. Warranty becomes invalidated in case of any mechanical damage, incorrect operation and/or making any repairs by unauthorized persons.
6. This consumer warranty does not exclude, restrict nor suspend any right of the Buyer ensuing if the product would not meet any of the sale contract terms.

.....  
sale date

serial number/date of manufacture

signature/stamp

Business entity that issued this warranty certificate:

P.H.P.U. AS Agnieszka Szymańska-Kaczyńska, Chumiętki 4, 63-840 Krobia, Poland