

EUROSTER 2026TXRX

Wireless, programmable thermostat for all types of heating and air conditioning devices.



MANUFACTURER: P.H.P.U. AS, Chumiętki 4, 63-840 Krobia, Poland

In order to take full advantage of thermostat capabilities please read this installation and operation manual carefully.

This manual is intended for the v8 07.2020 version of the thermostat

1. DESCRIPTION OF DEVICE

The Euroster 2026TXRX wireless thermostat allows you to control the indoor temperature in a very simple and efficient way, without the need for labor-intensive wiring between the thermostat and the heating device.

It is used to control the operation of the CH boiler and other heating system components. It controls electrical equipment, floor heating, and air-conditioning systems. The thermostat allows you to program 4 different temperature levels for each day of the week. Each temperature is modifiable within the range of 5 °C...35 °C.

2. BASIC FUNCTIONS OF THE THERMOSTAT

- Does not require leading cable connections between the thermostat and the controlled device
- Bidirectional communication ensures high operational reliability and resistance to interference
- 4 different temperature levels for each day of the week
- Intuitive, weekly programming in 10-minute increments with a program copying function
- Up to 6 RX receivers can be used
- Radio signal strength information
- Operating time counter for the heating/air-conditioning device
- Legible, backlit LCD
- Temperature setting with the accuracy of 0.2 °C
- Numerous useful functions: temporary temperature setting, vacation mode, discharged batteries indication, keypad interlock
- Temperature read-out accuracy of 0.1 °C
- Temperature reading correction
- Surface mounting

3. THERMOSTAT VISIBLE ELEMENTS

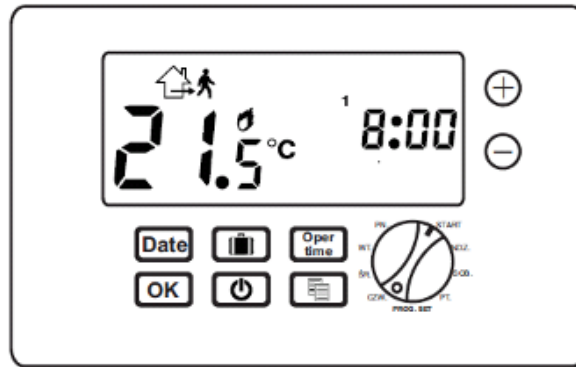









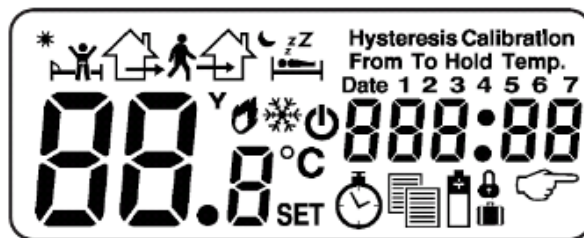

BODY





- \oplus and \ominus increase/decrease; press and hold to increase the rate of change
- **Date** press to read the current date; press and hold for 3 seconds to set the date and time
- **Power** switches the thermostat on and off (5 °C frost protection mode)
- **Oper time** press to read the operating time; press and hold for 3 seconds to clear, confirm using **OK**
- **Calendar** turns the vacation mode on/off
- **Document** press to select the program to be copied
- **OK** confirming

Notice: Changing any value causes the corresponding field on the display to flash. It should be understood as a confirmation request. If the user confirms the change with **OK**, the change is stored. If the change is not confirmed within 15 seconds, the thermostat cancels the change and restores normal operation.

DISPLAY



-  Program no. 1
-  Program no. 2
-  Program no. 3
-  Program no. 4
-  Heating on
-  Air conditioning on
-  Heating/air-conditioning device operating time counter
-  Switching the thermostat off – 5 °C frost protection mode
-  Copy function is active

-  Batteries are flat
-  Vacation mode
-  Thermostat is locked
-  Manual mode (the set temperature is maintained up to the next change of program)

4. VISIBLE ELEMENTS OF RX RECEIVER

- A. On/off switch for continuous operation of the heating device
- B. Button used to enter settings, signaling LEDs
- C. Output cable

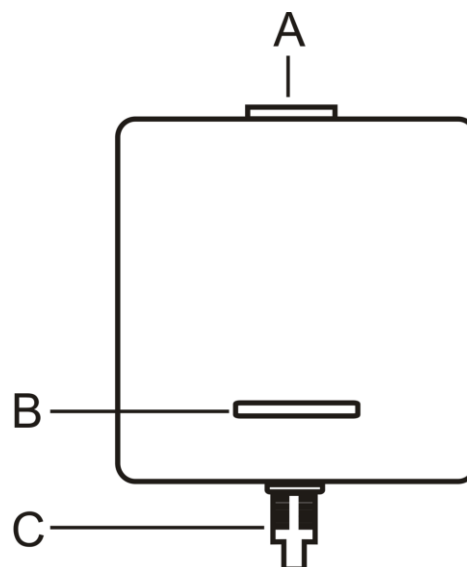

5. INSTALLATION

SAFETY RULES

CAUTION!

- **Prior to the commencement of any installation works read this manual carefully! Incorrect installation and improper use may lead to serious hazards to users or other persons and result in property damage!**
- **Prior to mounting or dismantling the set make sure that the heating/cooling system is de-energized!**
- **Voltages hazardous to life may be present on receiver output cables (power supply phase voltage), therefore only qualified technicians may install the thermostat!**
- **The electric connections performed and cables used shall be adequate to the applied loads and must conform to all requirements!**
- **Do not install the set in rooms with increased humidity; protect it against water and other liquids!**
- **Do not install any unit showing signs of mechanical damage!**
- **The thermostat is not a safety component. Additional protection devices must be used in systems prone to the risk of damage due to the failure of control systems!**
- **The device is not intended for use by children!**
- **Should there be any problem with the proper operation of the thermostat, please contact your technician or the manufacturer!**

PROPER PLACE OF INSTALLATION

The thermostat is designed for indoor installation. No cables are connected to the thermostat, thus it can be placed anywhere. In order to ensure fully efficient operation of the thermostat, please make sure that the following recommendations regarding the location of the thermostat are observed:

- Locate the thermostat at the height of approximately 1.5 m above the floor

- Avoid places with strong sunlight, near heating or cooling devices, situated directly by doors, windows, and other similar locations, where the temperature measurement could be easily disturbed by external conditions.
- Avoid places with poor air circulation, e.g. behind furniture.
- Avoid moist places due to the negative effect of moisture on the service life of the device.

OPENING THE THERMOSTAT

Using a cross-head screwdriver to loosen the housing locking screw. Separate the panel from the base, while being cautious about the hinges on the right-hand side of the controller.

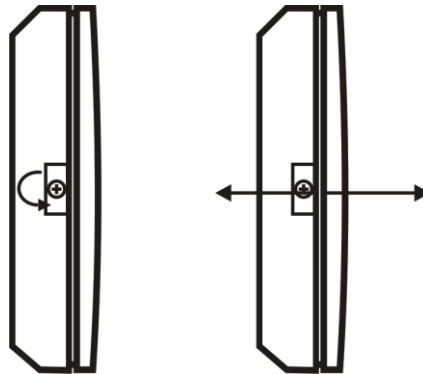

SELECTION OF THE THERMOSTAT OPERATING MODE

Euroster 2026 is equipped with 4 configuration jumpers. Factory settings are shown in italics:

- **Protection against overheating due to flat batteries: YES/NO**
If the batteries are flat, the thermostat can perform an emergency switch-off of the relay (protection against the uncontrolled operation of the heating device). When this function is off, the thermostat operates without any change until the battery is completely flat (risk of switching the heating permanently on).
- **Selection of sensor: *Internal/External***
The jumper is used to a sensor: internal (measures the air temperature at the location of the thermostat) or external (requires connecting an external sensor).
- **Type of system: *Air conditioning / Heating***
The jumper is used to select the type of system in which the regulator operates.
- **Type of algorithm: *ON-OFF / P.I.***
The thermostat can operate in on-off mode, in which it turns on the heating device when the temperature drops by the value of hysteresis (refer to p. 6) or in P.I. mode, in which it calculates the number of switch-ons per hour, depending on the temperature changes that have been made up to that moment.

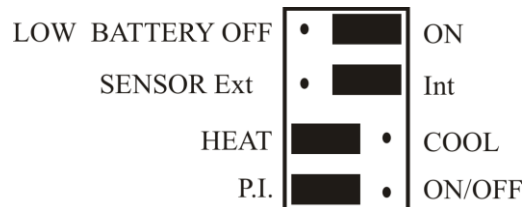

INSERTION AND REPLACEMENT OF BATTERIES

Place the batteries in the thermostat while observing the correct polarity. There are installation markings in the battery compartment. Then install (snap) the thermostat onto the base. The battery indicator will be visible when the battery voltage reaches the minimum allowable level. It is recommended to replace the batteries with new alkaline batteries before each heating season. Reprogram the controller if necessary.

CAUTION! Use only alkaline AA batteries to power the thermostat. Do not use rechargeable batteries because their voltage is lower and their effective time is shorter.

6. THERMOSTAT SETTINGS

SETTING DATE AND TIME

Notice: Settings may be confirmed in 2 ways: with the use of the **Date** or **OK** button. If **Date** is used, the thermostat continues with the next setting (hour > minute > year > month > day > hour). If **OK** is used, the thermostat stores the change and restores operation. If no key is pressed for 15 seconds, the change of setting is canceled. To set the date and time, proceed as follows:

1. Press and hold **Date** button for 3 seconds – the hour digits begin to flash.
2. Using **+** and **-** set the time. Confirm with **Date** button Minute digits begin to flash.
3. Repeat the steps for minutes, year, month, and day.
4. Having set the day of the month, confirm all changes by pressing **OK** button or press **Date** button to return to the settings and correct the values entered.

SETTING HYSTERESIS

1. Hold **+** and **-** for at least 3 seconds. The thermostat displays "Hysteresis" and shows the current value.
2. Use **+** and **-** buttons to select the desired value.
3. Confirm with **OK** or wait 15 seconds for the change to be canceled.

The idea of the hysteresis-based thermostat operation is described below:

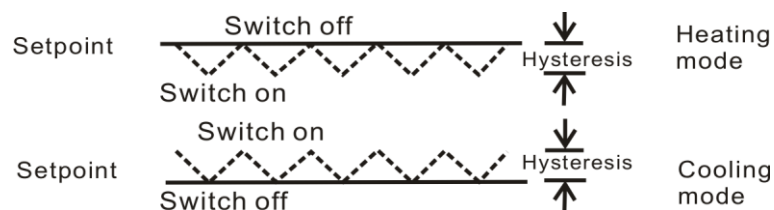

HEATING CURVE OPTIMIZATION ALGORITHM (PI)

2026 thermostat may be used with the heating curve optimization algorithm. This algorithm is suited for systems with underfloor water heating. It is used to limit room temperature fluctuations.

Unlike in on/off controls, the current status of the transmitter depends not only on the current difference between the preset and measured temperature but also on the past changes of temperature. For example, if the measured temperature is lower than the preset temperature for a long period, the thermostat switches the heating device permanently on.

To use the PI mode, you must set its parameters correctly. These consist of:

Cycle duration period ("Con") 1-5

It is the minimum period (minutes) for which the thermostat switches the transmitter on each time.

Maximum number of cycles per hour ('CPH') 3,6,9,12

The thermostat calculates the number of switch-ons and switch-offs (cycles) per hour (according to temperature changes).

Width of proportional control range ("Pb") 1.5-3.0

If the difference between the preset and measured temperature is included in the proportional control band, then the thermostat selects the switch-on and switch-off times. Outside of this band, the output operates in continuous on or off operation.

SETTING PI ALGORITHM PARAMETERS

1. Set the jumper to the P.I. position (Page 5) and press reset.
2. Hold \oplus and \ominus for at least 3 seconds. The thermostat displays "Con" and shows the current setting.
3. Use \oplus and \ominus buttons to select the desired value.
4. Confirm with **OK** or wait 15 seconds for the change to be canceled.
5. Repeat steps 2-3 for "CPH" and "Pb".

CORRECTION OF DISPLAYED TEMPERATURE (CALIBRATION)

The calibration range: -4.0 °C to +4.0 °C.

1. Turn the knob to the PN position.
2. Hold **Info** and **Date** buttons simultaneously for at least 3 seconds. The thermostat will show the current correction value.
3. Use \oplus and \ominus buttons to set the desired correction. The increment is 0.2 °C.
4. Confirm the change with **OK** or wait 15 seconds to cancel the change.

7. THERMOSTAT OPERATION

Euroster 2026 is a programmable thermostat. You can set 4 different temperatures for 4 different periods, for each day of the week individually. Setting programs for the entire week may be tedious, so the thermostat is equipped with a function to copy programs.

There are 2 settings for each program: The temperature and the starting time, which comes to be the ending time of the previous program.

When a given program is active, the temperature assigned to it is maintained.

The starting time of the program is defined with an accuracy of 10 minutes. Range: 12:00 a.m. to 11:50 p.m.

Programs are always implemented in the P1-P2-P3-P4 order. The user may set the starting hours of the programs in an order other than P1-P2-P3-P4, however, in such case the thermostat will disregard the programs that overlap each other.

Example:

P1-4 start consecutively; the user wants P4 to start before P3:

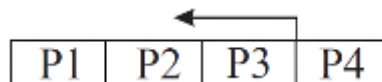

If P4 starts before P3, the thermostat automatically bypasses P3. The result is the following:

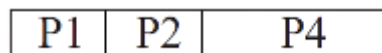

Similarly, if the user wants to move P2 and P3 "behind" P4:

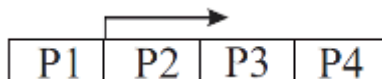





P2 and P3 programs will be bypassed (P4 starts before P2 and P3):



PROGRAMMING THE THERMOSTAT

Notice: The sequence of weekdays in programming is irrelevant.

1. Turn the knob to PN.
2. Set the desired temperature for P1 P1^* using \oplus and \ominus buttons. Confirm with **OK** button
3. Set the required P1 P1^* starting time using \oplus and \ominus buttons. Confirm with **OK** button

4. Set the desired temperature for P2  using \oplus and \ominus buttons. Confirm with **OK** button
5. Set the required P2  starting time using \oplus and \ominus buttons. Confirm with **OK** button
6. Similarly, set the temperatures and times for P3  and P4  programs.
7. Having set all parameters, turn the knob to the next day of the week (e.g. Tuesday).
8. Set the parameters for all programs on the next day.
9. Set all program parameters for all subsequent days in a similar way or copy programs (see page 7)
10. Turn the knob to the START position. The thermostat starts operation with the new settings.

COPYING PROGRAMS

Start with setting program parameters for one selected day as described above.

In the following description, the Monday program is to be copied to Tuesday, Thursday, and Friday.

1. Having set the program for Monday (the knob is still in the PN position), press  button.
2. The display indicates that the source of the program is Monday:



Notice: Press the  button again to exit the copy mode.

3. Use the knob to select a day of the week to which you want to copy the program from Monday, e.g. Tuesday
4. The display shows that the program is to be copied to Tuesday: digit 2 starts flashing.

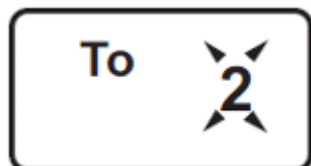



5. Press **OK** to copy the program. 2 stops flashing.
6. Turn the knob to a weekday which the Monday program is to be copied to, e.g. Thursday.
7. The display shows that the program is to be copied to Thursday. Digit 4 starts flashing.
8. Press **OK** to copy the program. 4 stops flashing.
9. Similarly, turn the knob to Friday and press **OK**; the program is copied
10. Turn the knob to the START position. The thermostat starts normal operation.

VACATION MODE







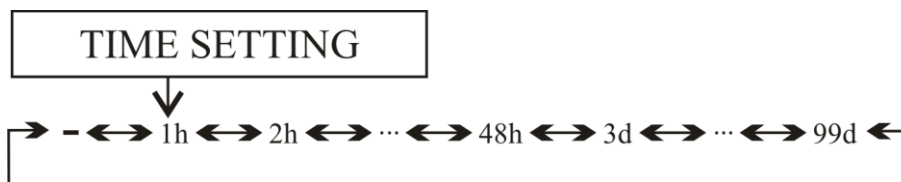

In holiday mode, the thermostat does not run a program but maintains the preset, constant temperature. The user sets the number of hours or days to maintain the preset temperature. The resolution for setting the time is 1 hour (for the period of 2 days) or 1 day (for the period of 3 to 99 days). An infinite time may be set, and in such a case, the holiday mode must be turned off manually.

Important note:

The holiday mode is activated when the settings are confirmed by pressing  button.  icon appears on the display. Leaving the thermostat idle for more than 15 seconds cancels the setting and restores normal operation.

Setting the vacation mode:



1. Turn the knob to the START and press  button. The thermostat goes to temperature setting mode – the temperature readout starts flashing. Use  and  buttons to adjust the desired temperature, then confirm with  or .
2. The display shows:
 - duration of the vacation mode on the left-hand side
 - the time or date when the vacation mode ends on the right-hand side
 Use  and  buttons to set the duration of the vacation mode.
3. The maximum number of hours is 48. The number of days is selected above this value. The number on the right in such a case indicates the date (the display shows "Date" and the symbol of the weekday)
You may also set the infinite duration of the vacation mode.
4. After entering the vacation duration setting, "1h" appears on the display. The changes are implemented according to the following order:
"- " means infinite duration; vacation mode in such a case may only be finished manually.
5. Having set the period, confirm it by pressing .

RESTORING NORMAL OPERATION

The thermostat automatically restores normal operation at a specified time. If the selected period was expressed in days, normal operation will be restored at midnight on the selected day (that is, at the beginning of the day).

If you plan to go back e.g. on Sunday, the thermostat will turn on the heating on Sunday at midnight and the room will be heated to normal temperature before you return.

If you select an infinite period, the vacation mode should be turned off manually.







In any case, the holiday mode is switched off by pressing  button.

TIME/DAYS INDICATION

If the preset period is expressed in hours, the letter "h" is shown after the number, whereas if it is expressed in days "d" appears on the display and "Date" is shown above the right number.

TEMPORARY CHANGE OF TEMPERATURE

Unlike in vacation mode, one does not set duration for the temporary change of temperature. This mode is active until the next program starts.

To activate this function, set the desired temperature with  and  buttons. It is stored after 3 seconds. You can also confirm the setting using . The display shows , and all buttons except  and  become locked.

Example:

P1 maintains a temperature of 20 °C from 9.00 a.m., whereas P2 maintains 21 °C from 2.00 p.m. At noon, the user activates a temporary change of temperature, sets the temperature to 15 °C. The target temperature will be:

20 °C – 9.00 a.m. ÷ 12.00 p.m

15 °C – 12.00 p.m. ÷ 2.00 p.m.



21 °C – 2.00 p.m. ÷

The function may be deactivated by turning the knob to any day of the week and then back to START.

Frost protection mode (switching the thermostat off after the heating season)

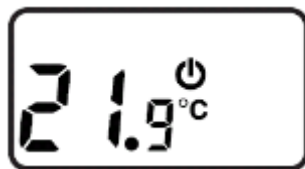
In the frost protection mode, the thermostat switches to maximum energy saving. If it is used with the air conditioning, it switches it off; if it controls the heating, it only maintains the minimum temperature to protect the system against freezing (5 °C).





To activate this function, press and hold  button for more than 3 seconds. The display becomes blank, only the measured temperature, the power symbol, and A-F letters indicating the anti-freeze mode are displayed. To deactivate this function, press  button for at least 3 seconds.

Locking thermostat settings

The thermostat features a setting interlock function. The active interlock is indicated by  symbol. In such a case it is not possible to change the settings. However, you can view them.

Locking the thermostat:

1. Turn the knob to the "SOB" position.
2. Hold  and  for at least 3 seconds. After 3 seconds, the thermostat is locked, and  symbol appears on the display.
3. Turn the knob to the "START" position.



Follow the same steps to unlock the thermostat.

Active interlock does not affect the thermostat operation.





CHECKING THE OPERATING TIME

The thermostat features a function to measure the operating time of the controlled device. It is used to determine a maintenance period or estimate costs.

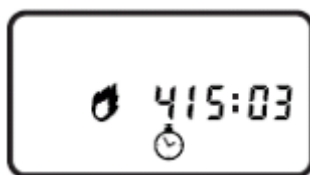
The maximum counted value is 999:59. Having reached this value reached, the counter stops.

1. Press  button to display the operating time. The thermostat displays the operating time and  or  symbol, depending on which device is operating.



2. Press  button (restore normal operation) or follow steps 3 to 5 to reset the counter.
3. Press and hold the  button for 3 seconds – the digits begin to flash.
4. Press  and the displayed value changes to 000:00 and stops flashing.
5. The thermostat restores normal operation after 15 seconds or when you press  button.

ANTI-STOP

The thermostat is equipped with the AntiStop function. The controlled device (e.g. pump) is switched on for at least 1 minute, at least once a week, even if the thermostat is in the frost protection mode. The operation is independent of the programs and is not configurable.

Factory settings

Air conditioning control

Monday Friday Saturday - Sunday

P1 6.00 a.m. / 23 °C P1 6.00 a.m. / 23 °C

P2 8.30 a.m. / 28 °C P2 11.00 a.m. / 22 °C

P3 3:00 p.m. / 22 °C P3 4.00 p.m. / 23 °C

P4 11.00 p.m. / 25 °C P4 11.00 p.m. / 25 °C

Heating control

Monday Friday Saturday - Sunday

P1 6.00 a.m. / 21 °C P1 08.00 a.m. / 21 °C

P2 8.30 a.m. / 18°C P2 08.30 a.m. / 21 °C

P3 04.00 p.m. / 21 °C P3 03.00 p.m. / 21 °C

P4 11.00 p.m. / 17 °C P4 11.00 p.m. / 17 °C

Hysteresis (all modes)

The factory preset hysteresis is 1 °C.

Jumper settings

The factory preset jumper position is as follows:

Type of system: Heating,

Selection of sensor: Internal,

Type of algorithm: ON-OFF,

Protection against overheating due to flat batteries: NO.

8. RX RECEIVER SETTINGS

ESTABLISHING CONNECTION BETWEEN 2026TX THERMOSTAT AND RX RECEIVER OR RECEIVERS (PAIRING)

Each thermostat and each receiver has a unique number that distinguishes it from others. It is not possible for any thermostat not paired with the particular receiver to interfere with the operation of another pair or set.

The thermostat may be paired with other receivers at any time. A blackout, battery replacement as well as a complete reset of all thermostat settings do not affect the pairing of devices in any way.

Pairing procedure:

- Press the RESET button (under the front flap)
- Remove the thermostat cover
- Press the button on the transmitter board three times, the LED starts flashing in red and green alternately

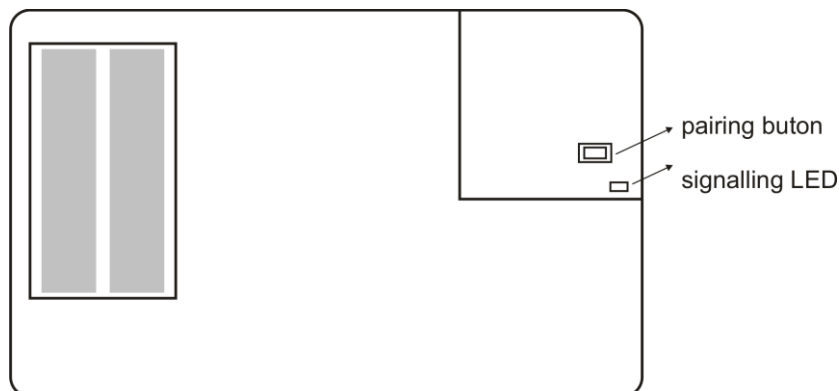

- Insert the RX receiver into the mains socket
- Press the button on the receiver 3 times – the blue LED lights up,
- When the connection is established, the blue LED on the receiver goes out
- If you use only one receiver, press the button on the transmitter board, the light goes out. The pairing mode is ended.

If you are going to pair multiple receivers (maximum 6), proceed as follows:

- When the first receiver is detected,

- insert the second receiver into a mains socket.
- Press the button on the receiver 3 times – the blue LED lights up,
- when the receiver is detected, the blue led goes out,
- Proceed similarly with the connection of the subsequent receivers, then press the button on the transmitter board. The pairing mode is ended.

Caution! Pairing mode is only available for 10 minutes after connecting the receiver to the mains, resetting it, or installing batteries in the thermostat! Factory-established pairs are paired, however, pairing may be repeated if necessary.

SELECTING OPERATING MODE

While holding the "B" button pressed, insert the receiver into a mains socket. Depending on the mode set, the green or red LED lights up. Each time the button is pressed, the operating mode changes. When you select the mode, the receiver restores operation.

Green – normally open mode (COM – NO). It is the mainly used operation mode. While the device operation indicator is active, the output cables are shorted.

Red – normally closed mode (COM – NC). While the device operation indicator is active, the output cables are opened.

Caution! The factory default setting is (COM-NO).

9. FIRST START

When inserted into the mains socket, the receiver indicates the relay operating mode. A flash of green LED – normally open mode (COM-NO), a flash of red – normally closed mode (COM-NC).

Any change in the status of the thermostat (switching the heating on/off) is made immediately by the receiver, while the confirmation that the radio signal is received from the transmitter is repeated every 15 minutes.

RADIO SIGNAL STRENGTH

The radio signal strength is indicated together with the reception of the transmitter signal. Radio signal reception is indicated in green. LED flashing three times stands for a very strong range, twice for a strong range, and once for sufficient range.

NO RADIO COMMUNICATION

If the communication between the thermostat and the receiver is interrupted (e.g. discharged batteries) and if this condition lasts for 60 minutes (no response from the receiver), the receiver switches to the frost protection mode. The heating device will be switched on every 3 hours for 20 minutes to prevent the rooms from being cooled down. At the time of re-establishing communication (e.g. replacement of batteries), the receiver will automatically switch the system off and resume operation.

If there is no radio communication, the green LED flashes rapidly.

CONTINUOUS OPERATION OF HEATING DEVICE (MAN)

In the event of system failure, it is possible to manually switch on the heating. Move the switch on the RX receiver to the MAN position. Such status is indicated by a rapid flashing of the red LED.

RECEIVER SIGNALING TABLE.

Function	Signaling
Pairing	Blue
Reception of radio signal	Green
No radio communication	Green – flashing
The heating/air-conditioning device is switched on	Red
Manual mode	Red – flashing

10. SAMPLE CONNECTION DIAGRAMS

The following diagrams are simplified and do not cover all elements necessary for the correct installation.

In arrangement with a 230 V 50 Hz device

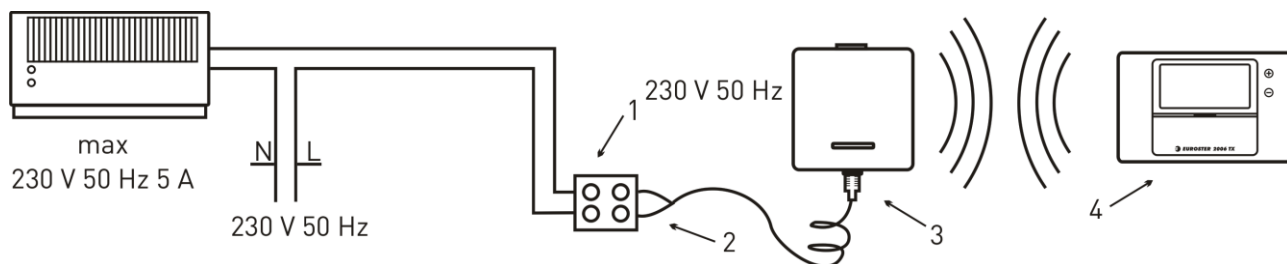

1. Electrical connection block
2. Output cable, using COM - NO contact (normally open)
3. Euroster RX (receiver)
4. Euroster TX placed in any room

In arrangement with a gas boiler

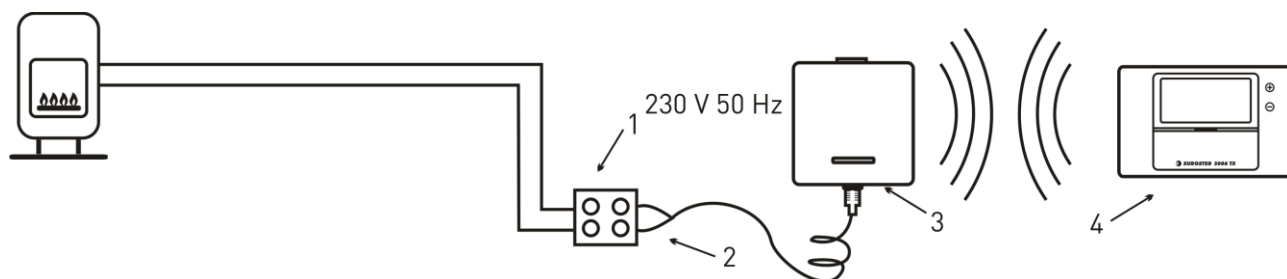

1. Electrical connection block
2. Output cable, using COM - NO contact (normally open)
3. Euroster RX (receiver)
4. Euroster TX placed in any room

11. MAINTENANCE

Do not use solvents and aggressive detergents to clean the thermostat, since they may damage the surface of the housing and the display. Clean the thermostat housing with a soft cloth.

12. DIMENSIONS

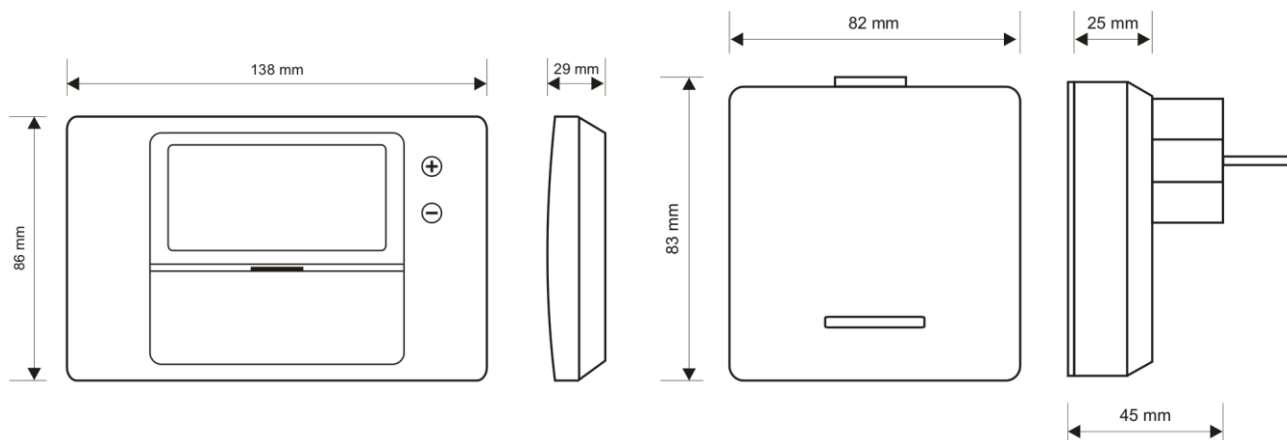

SPECIFICATIONS

Controlled device	heating/air-conditioning systems
Supply voltage	3 V (2 pieces of alkaline AA batteries) receiver – 230 V 50 Hz
Thermostat output	relay, voltage-free type, SPST
Maximum load	5 A 230 V 50 Hz
Temperature measurement range	0 °C...+50 °C
Temperature adjustment range	+5 °C...+45 °C
Temperature adjustment accuracy	0.2 °C
Temperature reading accuracy	0.1 °C
Hysteresis range	0.5, 1.0, 2.0, 4.0 °C, or PI mode,
Visual signalization	backlit LCD
Operation temperature	+5 °C...+40 °C
Storage temperature	-10 °C...+45 °C
Ingress protection rating	IP20
Color	White
Mounting method	thermostat – stand receiver – 230 V 50 Hz socket
Weight	Thermostat without batteries – 171 g receiver– 170 g
Warranty period	2 years
Length of the receiver output cable	2 m
The operating frequency of the set	868 MHz
Maximum power of transmission of the thermostat and receiver	< 25 mW
Thermostat class:	IV
Thermostat contribution to the seasonal energy efficiency of room heating	2%

13. KIT CONTENTS

- a) Euroster 2026TX thermostat
- b) Euroster RX receiver
- c) 2 pieces of alkaline AA batteries
- d) thermostat stand
- e) Installation and Operation Manual with Warranty Certificate

14. SIMPLIFIED DECLARATION OF CONFORMITY

P.H.P.U. AS AGNIESZKA SZYMAŃSKA-KACZYŃSKA hereby declares that the type of EUROSTER 2026TXRX equipment conforms to the following directives: 2014/35/EU (LVD), 2014/30/EU (EMC), 2014/53/EU (RED), 2011/65/EU (RoHS).

The complete text of the Declaration of EU conformity is available at the following Internet address: www.euroster.pl

ELECTRONIC WASTE MANAGEMENT INFORMATION



This product is designed and manufactured from high-quality materials and components suitable for reuse.

The crossed-out wheeled bin symbol located on the product (Fig. 1) means that the product is subject to selective collection in accordance with the provisions of the Directive 2012/19/EU of the European Parliament and of the Council.

The product contains batteries, which are marked with a crossed-out wheeled bin symbol (Fig. 1). The batteries are subject to selective collection in accordance with the provisions of the Directive 2006/66/EC of the European Parliament and of the Council.

Such marking informs that the electrical and electronic equipment, as well as batteries and accumulators, may not be disposed of together with other household waste after their service life has ended. The user is obliged to take the used devices and batteries or accumulators to a point of collection of waste electrical and electronic equipment and batteries and accumulators. The entities collecting such equipment, including the local collection points, shops, and municipal entities, set up an appropriate system enabling handover of such equipment and batteries and accumulators. The proper disposal of waste equipment, batteries, and accumulators contributes to the prevention of consequences hazardous to the health of persons and nature, resulting from the possible presence of hazardous components in the equipment and batteries and inaccurate storage and processing of such equipment and batteries.

Households play an important role in contributing to reuse and recovery, including recycling, of waste equipment. The attitudes influencing the protection of the common good of a clean environment are shaped at this level. Households are also one of the larger users of small equipment and its rational management at this level impacts the recovery of recyclables. Inaccurate disposal of this product may be penalized in accordance with national legislation.

WARRANTY CERTIFICATE EUROSTER 2026TXRX thermostat

Warranty terms:

1. The warranty is valid for 24 months from the device sale date.
2. The claimed thermostat together with this warranty certificate must be supplied to the seller.
3. Warranty claims shall be processed within 14 business days from the date the manufacturer has received the claimed device.
4. The device may be repaired exclusively by the manufacturer or by other parties clearly authorized by the manufacturer.
5. Warranty becomes void in case of any mechanical damage, incorrect operation, and repairs made by unauthorized persons.
6. This consumer warranty does not exclude, restrict nor suspend any right of the Buyer ensuing if the product would not meet any of the sale contract terms.

.....
Sale date

serial number

Stamp

Service:

date of manufacture

and signature

Phone No. 65-57-12-12

The business entity that issued this warranty certificate is:

P.H.P.U. AS Agnieszka Szymańska-Kaczyńska, Chumiętki 4, 63-840 Krobia, Poland