

EUROSTER 2006TXRX

Wireless, programmable thermostat for all types of heating and air conditioning devices.



MANUFACTURER: P.H.P.U. AS, Chumiętki 4, 63-840 Krobia, Poland

In order to take full advantage of thermostat capabilities please read this installation and operation manual carefully.

This manual is intended for v8 01.2020 version of the thermostat.

1. DESCRIPTION OF DEVICE

Wireless Euroster 2006TXRX thermostat is used to control room temperature simply and efficiently without a laborious installation of wires between the thermostat and the heating device.

It is used to control the operation of the CH boiler and other components of a heating system. It controls electrical equipment, floor heating, and air-conditioning systems. The thermostat operates with two temperature levels: comfort (day ☀) temperature and economical (night 🌙) temperature. Each temperature may be modified within the range of 5...35 °C. The thermostat is programmable in seven-day cycles with an accuracy of 0.5 hour, therefore it enables 48 temperature changes in 24 hours. It is possible to program different time ranges for each day of the week.

2. BASIC DEVICE FUNCTIONS

- Does not require laying cable connections between the thermostat and the controlled device
- User-friendly thermostat enabling easy control of temperature in living and utility rooms
- Bidirectional communication ensures high operational reliability and immunity to interference
- Possible cooperation with a maximum of 6 4040RX receivers
- Information on the strength of the radio signal
- Legible, backlit LCD
- Two temperature levels: comfort and reduced
- 0.2 °C accuracy of temperature setting
- 0.5-hour accuracy of range programming
- Numerous useful functions: temporary temperature setting, constant temperature, discharged batteries indication
- Temperature read-out accuracy of 0.1 °C
- Temperature readout correction
- Surface mounting

3. THERMOSTAT VISIBLE ELEMENTS

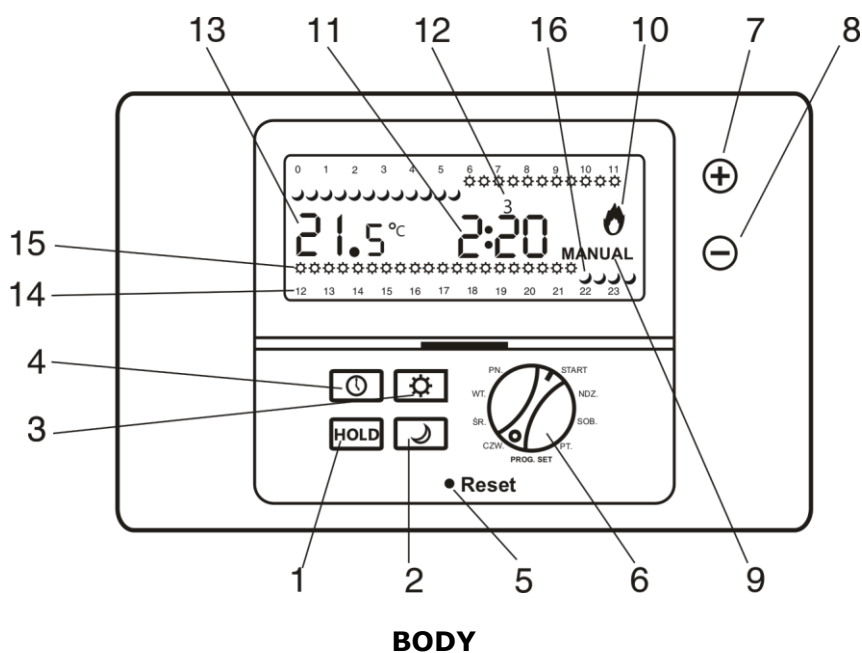

1. HOLD – use the button to switch the thermostat into the manual mode. The thermostat maintains the set temperature regardless of programmed settings. Press the HOLD button again to restore operation with programmed settings.
2. 🌙 economical temperature — Press the button to display the current economical temperature.
3. ⚙️ comfort temperature — Press the button to display the current comfort temperature.
4. Setting the clock
5. Restarting the thermostat
6. A knob used to select weekdays when programming a thermostat
7. 8. Multi-purpose setting buttons: ⊕ increase, ⊖ decrease

DISPLAY

9. Temporary change of temperature — MANUAL sign is displayed to indicate that the temperature has been changed manually by means of setting buttons.
10. An icon indicating the activation and operation of the controlled device.
11. Indication of the current time.
12. Current weekday, where 1 stands for Monday and 7 for Sunday, here: Wednesday.
13. Indication of the current temperature.
14. Indication of time in 24-hour mode.
15. ⚙️ icon over or under the indication of time determines the period of thermostat operation with the comfort temperature setting.
16. 🌙 icon over or under the indication of time determines the period of thermostat operation with the economical temperature setting.

4. VISIBLE ELEMENTS OF RX RECEIVER

- a) A switch activating the continuous operation of the heating device.
- b) A switch for entering settings, Signaling LEDs.
- c) Output cable.

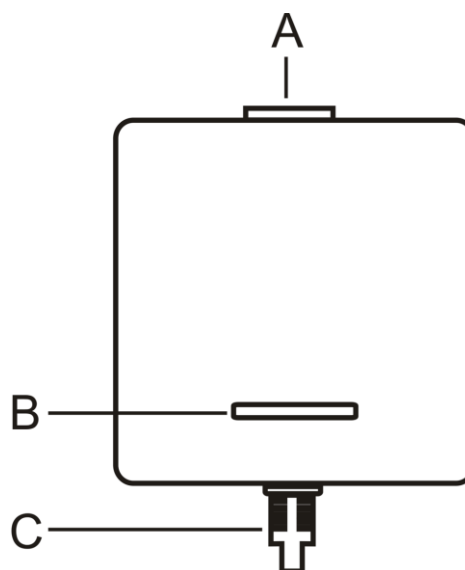

5. INSTALLATION

5.1. Safety rules

CAUTION!

- **Prior to the commencement of any installation works read this manual carefully! Incorrect installation and improper use may lead to serious hazards to users or other persons and result in property damage!**
- **Prior to mounting or dismantling the set make sure that the heating/cooling system is de-energized.**
- **Voltages hazardous to life may be present on receiver output cables (power supply phase voltage), therefore only qualified and certified technicians may install the thermostat!**
- **The electric connections performed and cables used shall be adequate to the applied loads and must conform to all requirements!**
- **Do not install the set in rooms with increased humidity; protect it against water and other liquids!**
- **Do not install any units showing signs of mechanical damage!**
- **The thermostat is not a safety component. Additional protection devices must be used in systems prone to the risk of damage due to the failure of control systems!**
- **The device is not intended for use by children!**
- **Should there be any problem with the proper operation of the thermostat, please contact your technician or the manufacturer!**

5.2. Proper place of installation

The thermostat is designed for indoor mounting. No cables are connected to the thermostat; thus, it can be placed anywhere. To ensure fully efficient operation of the thermostat, please make sure that the following recommendations regarding the location of the thermostat are observed:

- Locate the thermostat at the height of approximately 1.5m above the floor.
- Avoid places with strong sunlight, near heating or cooling devices, situated directly by doors, windows, and other similar locations, where the temperature measurement could be easily disturbed by external conditions.
- Avoid places with poor air circulation, e.g. behind furniture.
- Avoid moist places due to the negative effect of moisture on the service life of the device.

5.3. Opening the thermostat

Use a cross-head screwdriver to loosen the housing locking screw. Separate the panel and the base minding the hinges on the left side of the thermostat.

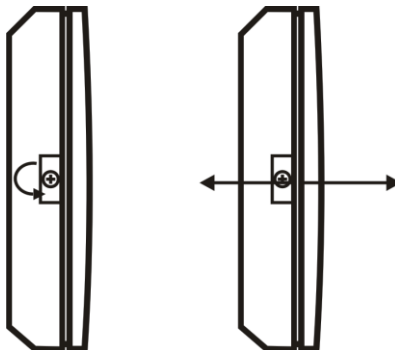

5.4. Selecting thermostat operating mode

J4 – the selection of heating or cooling operating mode	Jumper position	
	 J4 COOLING COOL	 J4 HEATING HEAT

J1 – the selection of sensor: floor or room sensor. This function is active only if the J4 jumper is in the heating position.	Jumper position	
	 J1 FLOOR The thermostat is controlled by the floor sensor.	 J1 ROOM The thermostat is controlled by the room sensor.

5.5. Insertion and replacement of batteries



Place the batteries in the thermostat while observing the correct polarity. There are installation markings in the battery compartment. Then install (snap) the thermostat onto the base.

The battery indicator will be visible when the battery voltage reaches the minimum allowable level. It is recommended to replace the batteries with new alkaline batteries before each heating season. Reprogram the controller if necessary.

CAUTION! Use only alkaline AA batteries to power the thermostat. Do not use rechargeable batteries because their voltage is lower, and their effective time is shorter.







6. THERMOSTAT SETTINGS

6.1. SETTING THE CLOCK

- a. Set the knob in the START position.
- b. To set the clock press .
- c. Use \oplus or \ominus buttons to select a weekday.
- d. To set the hour push  button again.
- e. Use \oplus or \ominus buttons to set correct time.
- f. Repeat the  and \oplus / \ominus sequence to set minutes.
- g. After five seconds the setting is stored, and the device restores operation.





6.2. MODIFICATION OF TEMPERATURE LEVELS – comfort and economical temperature

Temperatures stored under  and  symbols are applicable for all weekdays.

- Set the knob to the START position.
- To allow a change of preset comfort temperature press  button.
To allow a change of preset economical temperature press  button.
- Having pressed  or  button again the displayed setting value starts flashing.
- Use  and  buttons to set the desired temperature.
- After five seconds the setting is stored, and the device restores operation.

 and  buttons are inactive when the temporary (MANUAL) temperature is active. Press HOLD twice to activate the buttons.



6.3. SETTING HYSTERESIS (SWITCH ON/OFF DIFFERENCE)

- Set the knob in the START position.
- Simultaneously press and hold for 3 sec.  and  buttons.
- Use  or  button and watch the readout indication to select the required hysteresis value of 0.4°C or 1°C.
- After five seconds the setting is stored, and the device restores operation.

6.4. TEMPERATURE READOUT CORRECTION

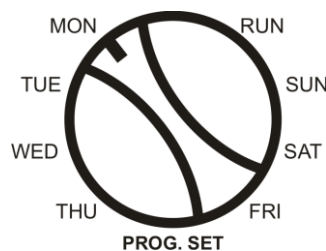
- Set the knob in the "MON" position.









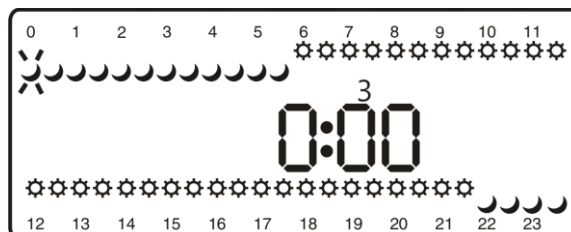



- Simultaneously press and hold for 3 sec. HOLD and  buttons.
- Use  or  button and watch the readout indication to set the correction of the displayed temperature, within the range of -2°C to +2°C with the step of the change of 0.2°C.
- After five seconds the setting is stored, and the device restores operation.

6.5. SETTING PROGRAMS FOR INDIVIDUAL WEEKDAYS

- Set the knob to the selected weekday to be programmed (the example in the figure shows Wednesday).
- The display appearance changes as shown in the figure below:





- Use  or  buttons to select the desired period. To facilitate the selection, the period of the range and flashing  or  symbol is displayed.
- To change the temperature  to  press adequately  or  button. Whenever  or  is pressed, a temperature is programmed for a period of 0.5 hour.
- IMPORTANT NOTE!** Having programmed all 7 weekdays return the knob to START position. Then the thermostat automatically starts the operation according to the programmed settings.

6.6. RESTORING FACTORY SETTINGS

- Press simultaneously HOLD and  buttons and while holding them press RESET.
- Release all buttons.
- Press the HOLD button twice and press RESET again.



Factory settings



Default temperatures:

Heating mode  20.4°C  16.2°C

Air-conditioning mode  22.0°C  25°C



Default time ranges:

Monday – Friday  6.00 a.m. to 10.00 p.m.  10.00 p.m. to 6.00 a.m.

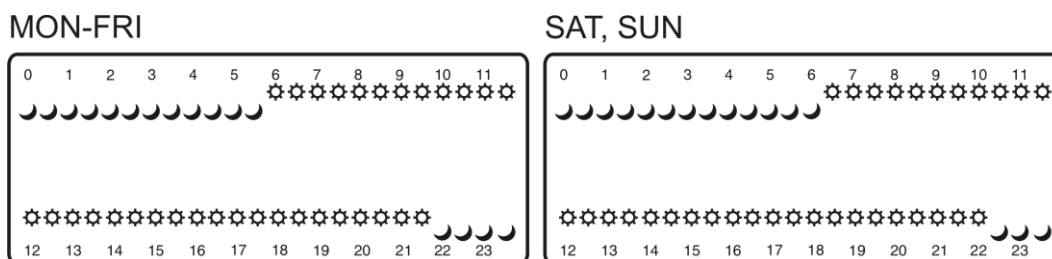
Saturday – Sunday  6.30 a.m. to 10.30 p.m.  10.30 p.m. to 6:30 a.m.



6.7. SWITCHING OFF THE PROGRAM (operation with constant setting) / HOLD









- Set the knob in the START position.
- To switch off the program and set the constant operating temperature press HOLD. "Temp Set" (temperature setting) and "Hold" (program switched off) will be displayed.
- Use  and  buttons to set the desired temperature.
- The display will flash for approx. 8 sec. upon the selection of the desired temperature and then it will show the current room temperature. The thermostat starts operating in the constant setting mode. From this moment, the thermostat maintains a constant temperature, set by the user, regardless of the programs.
- To restore operation according to the program, press HOLD.

6.8. 5 °C FROST PROTECTION SETTING

- Set the knob in the START position.
- Press HOLD and hold it for 5 sec. "A-F" letters appear on the display.
- Frost protection function is activated. Regardless of the moment of switching it on, the function is active until Monday 0.00 a.m.
- To switch off the frost protection function and restore operation according to the program press HOLD again.

6.9. TEMPORARY (MANUAL) TEMPERATURE CHANGE

Permits a temporary change of temperature without modifying the stored programs. At the nearest change of the comfort to economical temperature or in reverse, the thermostat automatically restores operation according to the stored program.

- Set the knob in the START position.
- Press  or  button, to show the readout of the current  or  temperature setting.
- Use  and  buttons to set the desired temperature.
- After the selection of the desired temperature, the display will flash for approx. 8 sec. afterward the main screen will be displayed. The thermostat starts the operation according to the temporary temperature change. During the operation according to temporary temperature change in a given time range the  or  symbols will disappear from the main display screen; MANUAL inscription will appear instead.
- To restore the operation according to the program, turn the knob in either way and return it to the START position.

6.10. FLOOR SENSOR CONNECTION

- Check if J1 jumper is in the floor position (point 4.4.)
- Connect the floor sensor to terminals No. 4 and 5 in the thermostat.
- Reset the thermostat.
- The thermostat operates according to floor sensor indications. The range of controlled temperature increases to 45°C. The standard temperature sensor is inactive.

7. RX RECEIVER SETTINGS

7.1. Establishing a connection between 2006TX thermostat with RX receiver or receivers (pairing)

Each thermostat and each receiver has a unique number distinguishing it from other thermostats. It is not possible for any thermostat not paired with the particular receiver to interfere with the operation of another pair or set.

The thermostat may be paired with other receivers at any time. Neither a blackout, battery replacement nor a complete reset of all thermostat settings affects the pairing of devices in any way.

Pairing procedure:

- RESET button (under the front cover),
- remove the thermostat housing,
- press the button on the transmitter plate three times – the signaling LED starts flashing alternately in red and green,

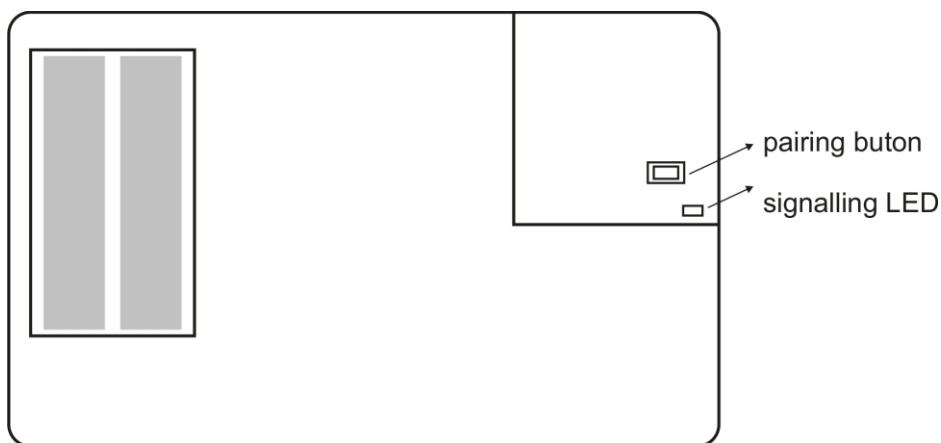

- insert the RX receiver to the power socket,
- press the receiver button 3 times – blue signaling LED lights up,
- when the connection is established the blue LED switches off,
- if one receiver only is used, press the transmitter button, the LED switches off. Pairing mode is completed.

If several (maximum 6) receivers are to be paired:

- After detection of the first receiver,
- Insert the second receiver to the power socket
- Press the receiver button 3 times – blue signaling LED lights up
- After detection of the first receiver, the blue LED switches off
- Follow the same steps to connect the subsequent receivers, then press the transmitter button. Pairing mode is completed.

Note!

**Pairing mode is only available for 10 minutes after connecting the receiver to the mains, restoring factory settings and inserting batteries into the thermostat!
Factory-established thermostat–receiver pairs are paired; however, pairing may be repeated if necessary.**

7.2. Selection of operating mode

While keeping the button "B" pressed insert the receiver into the power socket. Depending on the preset mode green or red LED lights up. Each pressing of the button changes the operating mode. After a mode is selected, the receiver restores operation.

Green – normally open mode (COM – NO). It is the most commonly used operation mode. While the device operation indicator is active the output cables are shorted.

Red – normally closed mode (COM – NC). While the device operation indicator is active the output cables are opened.

Caution! Normally open mode (COM – NO) is preset by default.

8. FIRST START

After being connected to the power socket the receiver signals the transmitter operating mode. A flash of the green LED – normally open mode (COM – NO), a flash of red LED – normally closed mode (COM – NC).

Each and every change to thermostat status (switching the heating on/off) is executed by the receiver instantly, whereas the signalization confirming the reception of the radio signal from the transmitter is repeated every 15 minutes.

8.1. Strength of radio signal

Information on the strength of the radio signal is communicated together with the signalization of the reception signal from the transmitter. The reception of the radio signal is signaled in green. Three flashes of the LED stand for exceptionally good reception, two flashes stand for good reception, and one flash – for sufficient reception.

8.2. Lack of radio communication

If the communication between the thermostat and the receiver is interrupted (e.g. discharged batteries) and such status lasts for 2 minutes (no response from the receiver) then the receiver switches into the frost protection mode. The heating device will be switched on for 20 minutes every 3 hours so that the rooms are not cooled down. At the time of re-establishing communication (replacement of batteries), the receiver turns the system off and automatically resumes the operation.

Lack of radio communication is signaled by a fast flashing green LED.

8.3. Continuous operation of the heating device (MAN)

In the case of system failure, it is possible to switch the system on manually. Move the switch on the RX receiver to the MAN position. Such status is signaled by fast flashing red LED (in the heating mode) or blue LED (in the cooling mode).

8.4. Receiver signaling table

Function	Signal
Pairing	Blue
Reception of radio signal	Green
Lack of signal	Green – flashing
The heating device switched on	Red
Manual mode in heating operation	Red – flashing
The air-conditioning device switched on	Blue
Manual mode in air-conditioning operation	Blue – flashing

9. Sample Connection Diagrams

The following diagrams are simplified and do not cover all elements necessary for the correct installation.

In arrangement with a 230 V 50 Hz device

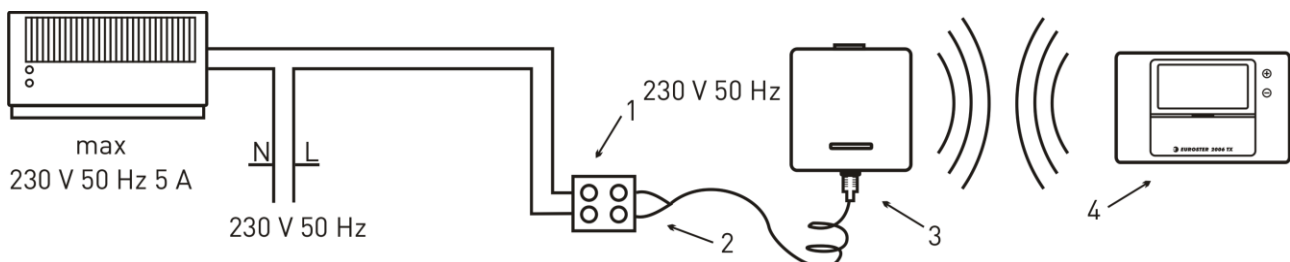

1. Electrical connection block
2. Output cable using COM - NO contact (normally open)

3. Euroster RX (receiver)
4. Euroster TX placed in any room

In arrangement with a gas boiler

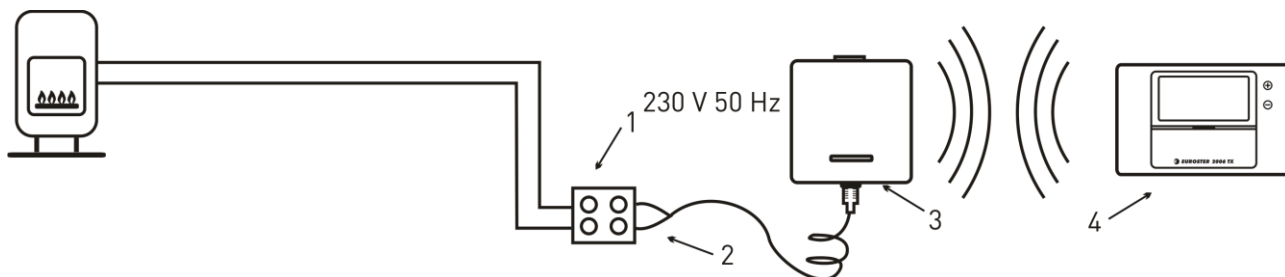

1. Electrical connection block
2. Output cable using COM - NO contact (normally open)
3. Euroster RX (receiver)
4. Euroster TX placed in any room

10. MAINTENANCE

Do not use solvents and aggressive detergents to clean the thermostat, since they may damage the surface of the housing and the display. Clean the thermostat housing with a soft cloth.

11. DIMENSIONS

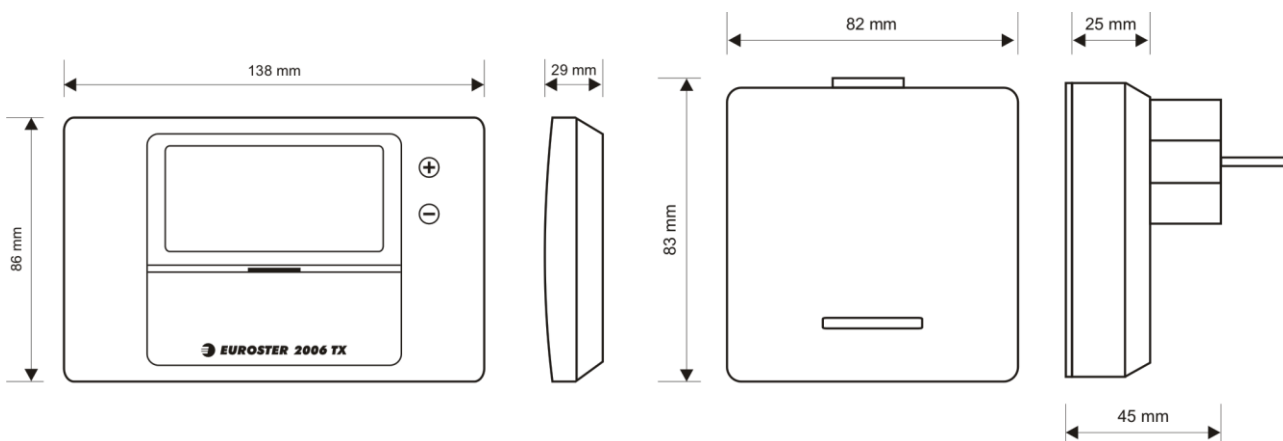

12. TECHNICAL DATA

Controlled device	heating / air conditioning systems
Supply voltage	3 V (2 pieces of alkaline AA batteries) / receiver – 230 V 50 Hz
Thermostat output	relay, voltage-free type, SPST
Maximum load	5 A 230 V 50 Hz
Temperature measurement range	0 °C...+50 °C
Temperature adjustment range	+5 °C...+35 °C +5 °C...+45 °C while in floor sensor mode
Temperature adjustment accuracy	0.2 °C
Temperature readout accuracy	0.1 °C
Hysteresis range	0.4 °C or 1 °C
Visual signalization	backlit LCD
Operation temperature	+5 °C...+40 °C
Storage temperature	-10 °C...+45 °C
Ingress protection rating	IP 20
Color	white
Mounting method	thermostat – stand receiver – 230 V 50 Hz socket

Weight	thermostat weight without batteries – 115 g receiver – 170 g
Warranty period	2 years
Length of the receiver output cable	2 m
Frequency of set operation	868 MHz
Maximum power of transmission of the thermostat and the receiver	< 25 mW
Thermostat class:	I
Thermostat contribution to the seasonal energy efficiency of room heating	1%

13. KIT CONTENTS

- **Euroster 2006TX**, thermostat
- **Euroster RX**, receiver
- 2 pieces of alkaline AA batteries
- thermostat stand
- Installation and Operation Manual with Warranty Certificate

14. SIMPLIFIED DECLARATION OF CONFORMITY

P.H.P.U. AS AGNIESZKA SZYMAŃSKA-KACZYŃSKA hereby represents that the type of EUROSTER 2006TXRX equipment conforms to the following directives: 2014/35/EU (LVD), 2014/30/EU (EMC), 2014/53/EU (RED), 2011/65/EU (RoHS).

The complete text of the Declaration of EU conformity is available at the following Internet address: www.euroster.pl

15. ELECTRONIC WASTE MANAGEMENT INFORMATION



This product is designed and manufactured from high-quality materials and components suitable for reuse.

The crossed-out wheellie bin symbol located on the product (Fig. 1) means that the product is subject to selective collection under the provisions of the Directive 2012/19/EU of the European Parliament and of the Council.

The product contains batteries, which are marked with a crossed-out wheellie bin symbol (Fig. 1). The batteries are subject to selective collection in accordance with the provisions of the Directive 2006/66/EC of the European Parliament and of the Council.

Such marking informs that the electrical and electronic equipment as well as batteries and accumulators may not be disposed of together with other household waste after their service life has ended. The user is obliged to take the used devices and batteries or accumulators to a point of collection of waste electrical and electronic equipment and batteries and accumulators. The entities collecting such equipment, including the local collection points, shops, and municipal entities, set up an appropriate system enabling handover of such equipment and batteries and accumulators. The proper disposal of waste equipment, batteries and accumulators contributes to the prevention of consequences hazardous to the health of persons and nature, resulting from the possible presence of hazardous components in the equipment and batteries and from inaccurate storage and processing of such equipment and batteries.

Households play an important role in contributing to reuse and recovery, including recycling, of waste equipment. The attitudes influencing the protection of the common good of a clean environment are shaped at this level. Households are also one of the larger users of small equipment and its rational management at this level impacts the recovery of recyclables. Inaccurate disposal of this product may be penalized in accordance with national legislation.

WARRANTY CERTIFICATE
EUROSTER 2006TXRX thermostat

Warranty terms:

1. The warranty is valid for 24 months from the device sale date.
2. The claimed thermostat together with this warranty certificate must be supplied to the seller.
3. Warranty claims shall be processed within 14 business days upon the day when the manufacturer received the claimed device.
4. The device may be repaired exclusively by the manufacturer or by a party clearly authorized by the manufacturer.
5. Warranty becomes void in case of any mechanical damage, incorrect operation, and repairs made by unauthorized persons.
6. This consumer warranty does not exclude, restrict nor suspend any right of the buyer if the product does not meet any of the sale contract terms.

.....

Sale date	Serial number / date of manufacture	Stamp and signature	Phone No. (+48) 65-57-12-012
-----------	--	------------------------	---------------------------------

The business entity that issued this Warranty Certificate:
P.H.P.U. AS Agnieszka Szymańska-Kaczyńska, Chumiętki 4, 63-840 Krobia, Poland